

Pro Series

Professional VHF Wireless Systems

- PRO 127G** UniPak™ System with Guitar Cable
- PRO 127H** UniPak™ System with Headworn Microphone
- PRO 127L** UniPak™ System with Lavalier Microphone
- PRO 128** Handheld Dynamic Microphone System

Installation and Operation



Installation and Operation

This device complies with part 15 of the FCC Rules. Operation is subject to the condition that this device does not cause harmful interference.

This device complies with INDUSTRY CANADA R.S.S. 210, en conformité avec IC: RSS-210/CNR210. Operation is subject to the following conditions: 1) This device may not cause harmful interference and 2) this device must accept any interference received, including interference which may cause undesired operation.

CAUTION! Electrical shock can result from removal of the receiver cover. Refer servicing to qualified service personnel. No user-serviceable parts inside. Do not expose to rain or moisture.

The circuits inside the receiver and transmitter have been precisely adjusted for optimum performance and compliance with federal regulations. Do not attempt to open the receiver or transmitter. To do so will void the warranty, and may cause improper operation.

Notice to individuals *with implanted cardiac pacemakers or AICD devices:*

Please read the cautionary notice on **back cover** before operating this or any other source of RF (radio frequency) energy.

Introduction

Thank you for choosing an Audio-Technica professional wireless system. You have joined thousands of other satisfied customers who have chosen our products because of their quality, performance and reliability. This wireless microphone system is the successful result of years of design and manufacturing experience.

Each professional wireless system includes a receiver and either a body-pack or a handheld transmitter on a specific crystal-controlled frequency.

The versatile UniPak™ body-pack transmitter has both low- and high-impedance inputs plus a bias connection, for use with dynamic and electret condenser microphones, as well as Hi-Z instrument pickups. Both the handheld and UniPak transmitters use internal 9-volt batteries and have Off/Standby/On switches, battery condition indicators, and battery-save switches.

Please note that in a multi-channel application, there must be a transmitter-receiver combination on a *separate* frequency for each input desired (only one transmitter for each receiver). Because the wireless frequencies are in or near VHF TV frequencies, only certain wireless frequencies are useable in a particular geographic area. (Frequency selection information will be found on pages 8 and 9.)

Receiver Installation

Location

For best operation the receiver should be at least 3' above the ground and at least 3' away from a wall or metal surface to minimize reflections. The transmitter should also be kept at least 3' away from the receiver.

Keep the antennas away from noise sources such as digital equipment, motors, automobiles and neon lights, as well as large metal objects.

Output Connection

The receiver provides unbalanced, aux-level output from a 1/4" phone jack; output cable is not included. Use a shielded audio cable with 1/4" phone plug to connect the receiver's AF Out jack to the mixer/amplifier's aux-level input.

Power Connection

Turn the receiver's volume control all the way down. Connect the included AC adapter to the DC power input on the back of receiver. (Note that the receiver has no power off/on switch. The receiver will be on whenever the AC adapter is connected and plugged into the AC outlet. Unplug the AC adapter from the AC outlet whenever the system is not in use – both for safety, and to conserve energy.)

Antennas

A novel "dipole" antenna system on the receiver improves operation by providing a "ground" element in addition to the usual "signal" element. While holding the telescoping antennas at their base, fully extend each of them. Position the rear-most (signal) antenna vertically and the front ("ground") antenna horizontally, in the shape of an "L" (Fig. A). *Do not move either antenna beyond vertical (to the left of straight-up).* To do so may damage the antenna and/or receiver.

For best performance, locate the receiver so its vertical antenna is in direct line-of-sight to the transmitter's likely operating position.

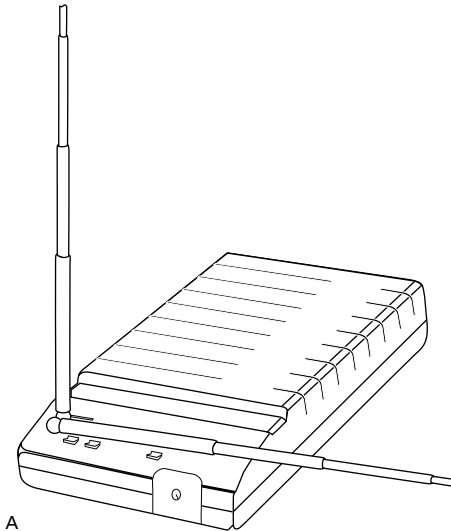

Fig. A

Transmitter Setup

Battery Selection

An alkaline 9-volt battery is recommended.

UniPak™ Transmitter Battery Installation

Make certain the power switch on the bottom of transmitter is in the "Off" position.

Slide off the battery cover as shown in Figure B.

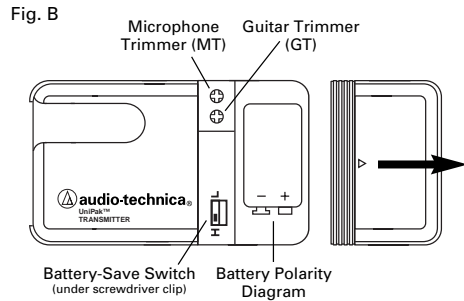

Carefully insert a fresh 9-volt alkaline battery, observing correct polarity as marked inside the battery compartment. The transmitter housing is designed to prevent incorrect installation of the battery. **Do not force the battery in.**

Replace the battery cover (Fig. C).

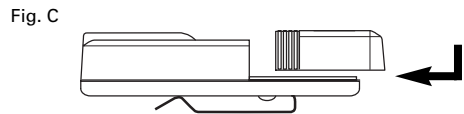

Move the power switch to "On" and make certain the red battery condition indicator is strongly illuminated.

Return the power switch to the "Off" position.

Handheld Transmitter Battery Installation

Make certain the power switch on the bottom of transmitter is in the "Off" position.

While holding the upper part of the transmitter body just below the ball-screen, unscrew the lower body and slide it downward to expose the battery compartment (Fig. D). **Do not attempt to pull the lower body farther down, or to gain access to the electronics.**

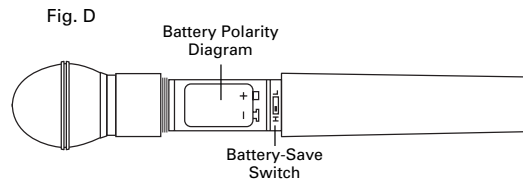

Lift the white "battery keeper" arm until it sticks straight out from the mic body (no higher). Then carefully insert a fresh 9-volt alkaline battery, observing correct polarity as marked inside the battery compartment. The transmitter housing is designed to prevent incorrect installation of the battery. **Do not force the battery in.**

Move the white arm down until it presses on the battery, then slide the lower body portion back up until it covers the battery and engages the threads of the upper body. Screw the body back together; do not overtighten.

Move the power switch on the bottom of transmitter to "On" and make certain the red battery condition indicator is strongly illuminated.

Return the power switch to the "Off" position.

Battery Condition Indicator

The red battery condition indicator (Fig. E/F) should light strongly with a fresh battery. As the battery weakens, the indicator will grow dimmer. When the indicator becomes very dim or goes out, there is little life left in the battery. Replace it at once for continued operation of the transmitter.

All transmitters feature battery-save switches (Fig. B/D). As supplied, the switch is set in the High position for maximum range. Switching to the Low position increases battery life by reducing power. (Note: Effective range decreases when the switch is set in the Low position.)

UniPak™ Transmitter Input Connection

Connect an audio input device (microphone or guitar cable) to the input connector on the bottom of the transmitter.

Transmitting Antenna

The UniPak transmitter includes a permanently-attached flexible antenna. For best results, allow the antenna to hang freely and full length from the bottom of the transmitter. If the received signal is marginal, experiment with different transmitter positions on your body or instrument; or try repositioning the receiver. **Do not attempt to remove, replace or change the length of the transmitting antenna.**

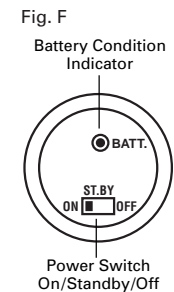
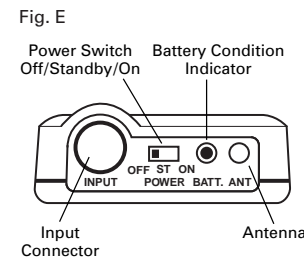

System Operation

Check the frequency of the system against the chart on page 9 to ensure you have a proper frequency for your area. Operating frequency is shown on the back panel of the receiver and on the transmitter.

Turn down the volume control of the receiver as well as input controls on the mixer/amplifier. Do *not* switch on the transmitter yet.

Receiver on...

Plug the AC adapter into an AC power source. The red power indicator will light.

Transmitter on...

When the transmitter is switched on, the receiver's yellow RF signal indicator will light. The transmitters have a 3-position power switch. When the switch is set to "Standby" (ST or ST.BY), the transmitter produces RF with no audio signal. When the switch is "On," the transmitter produces both RF and audio. Maximum audio input to the transmitter will cause the receiver's red AF Peak indicator to light.

Receiver Squelch

The squelch control on the back panel of the receiver is preset at the factory, but can be adjusted if you must use the system in a high RF interference area. If there is audio output from the receiver when *your* transmitter is *off*, adjust the squelch control so the system will receive the signal from *your* transmitter but "squelch" or eliminate the unwanted background RF noise. This adjustment can cause a reduction in useable range of the wireless transmitter, so set the control to the *lowest* position which reliably mutes the unwanted RF signals.

Input Level Adjustment

Input trimmer controls in the transmitters enable you to use microphones or guitars with different sensitivities, or to adjust for different acoustic levels.

CAUTION!

*The small trimmer controls are delicate; use only the supplied screwdriver.
Do not force the trimmers beyond their normal 260° range of rotation.*

Return the screwdriver to its storage clip when not in use.

Adjusting Input Levels-UniPak Transmitter

Slide the battery cover off the top part of transmitter and remove the screwdriver from its clip (Fig. B). Gently turn the "MT" (mic trimmer) and "GT" (guitar trimmer) controls to their full counter-clockwise positions.

• Microphone: Adjusting input level

While speaking/singing into the microphone at typically-loud levels, carefully turn the MT control clockwise while watching the receiver's AF Peak indicator. Increase the MT control setting until the AF Peak indicator lights. This indicates that maximum transmitter modulation without significant distortion has been reached. *(When using a guitar, return the MT control setting to minimum.)*

• Guitar/Instrument: Adjusting input level

While playing at typically-loud levels, carefully turn the GT control clockwise while watching the receiver's AF Peak indicator. Increase the GT control setting until the AF Peak indicator lights. This indicates that maximum transmitter modulation without significant distortion has been reached. *(When using a microphone, return the GT control setting to minimum.)*

After adjusting input levels, return the screwdriver to its clip and reinstall the battery cover. No further transmitter gain adjustments should be needed, as long as the input device and the acoustic input level are not changed.

Adjusting Input Level-Handheld Transmitter

Unscrew the lower body cover and slide it downward, exposing the screwdriver and gain trimmer (Fig. G). Remove the screwdriver and *gently* turn the gain trimmer control to its full counter-clockwise position.

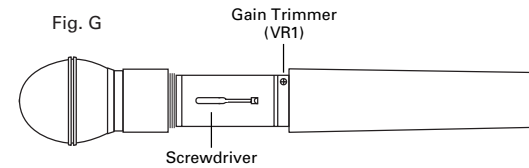

While speaking/singing into the microphone at typically-loud levels, carefully turn the trimmer control clockwise while watching the receiver's AF Peak indicator. Increase the control setting until the AF Peak indicator lights. This indicates that maximum transmitter modulation without significant distortion has been reached.

Return the screwdriver to its clip and close and secure the lower body. (Make certain that the white "battery keeper" arm is inside the body.) No further transmitter gain adjustments should be needed, as long as the acoustic input does not change significantly.

Ten Tips To Obtain The Best Results

1. Use only fresh alkaline batteries. Do not use "general purpose" (carbon-zinc) batteries.
2. Position the receiver so that it has the fewest possible obstructions between it and the normal location of the transmitter. Line-of-sight is best.
3. The transmitter and the receiver should be as close together as conveniently possible.
4. Do not place the receiver antennas within three feet of another receiver or antenna.
5. The receiver antennas should be kept away from any metal.
6. A receiver cannot receive signals from two transmitters at the same time.
7. In the UniPak transmitter, the "MT" or "GT" input control *not* in use should be set to *minimum*.
8. If the volume control of the receiver is set too high, it may over-drive the input of the mixer/amplifier, causing distortion. Conversely, if the receiver output is set too low, the overall signal-to-noise ratio of the system may be reduced. Adjust the output level of the receiver so the highest sound pressure level going into the microphone (or the loudest instrument playing level) causes no input overload in the mixer, and yet permits the mixer level controls to operate in their "normal" range (not set too high or too low). This provides the optimum signal-to-noise for the entire system.
9. Turn the transmitter off when not in use. Remove the battery if the transmitter is not to be used for a period of time.
10. Unplug the AC adapter from the AC outlet when the system is not in use.

Wireless Operating Frequencies

Frequency Selection

Each transmitter/receiver system operates on a single factory-aligned, crystal-controlled frequency. Available frequencies are shown in the chart on the following page.

Operating frequency is specified by a two- or three-character code, such as "T2" or "12L," in addition to the actual frequency in MHz. The frequency of each transmitter appears on a label on the outside of the unit. The frequency of each receiver appears on a label on the back of the unit and the frequency of each system appears on the outer carton. For future reference, please record them in the space provided below.

Because most of these authorized frequencies are shared with TV broadcasting, frequency selection is largely dependent upon which TV broadcast channels are in operation *where the wireless system is to be used*.

RF Interference

If you encounter receiving interference (from other than an operating TV station), often it can be eliminated by adjusting the receiver's squelch control, as described on page 6.

Please note that wireless frequencies are shared with other radio services. According to Federal Communications Commission regulations, "Wireless microphone operations are unprotected from interference from other licensed operations within the band. If any interference is received by any Government or non-Government operation, the wireless microphone must cease operation..."

If you need assistance with operation or frequency selection, please contact your dealer or the A-T professional division.

Extensive wireless information is available on the A-T Web site at www.audio-technica.com.

For future reference, please record your system information here (the serial numbers appear inside the battery compartment of each transmitter, and on the bottom of each receiver):

Operating Frequency

Freq. Code ___ ___ ___ Frequency ___ ___ . ___ ___ MHz

Receiver

Model PRO-R1 Serial Number ___ ___ ___ ___ ___

Transmitter

Model ATW-T ___ ___ Serial Number ___ ___ ___ ___ ___

System Operating Frequencies

| Application | Freq. Code | Freq. (MHz) |
|--|------------|-------------|
| • Traveling frequencies: (Normally work anywhere in the U.S.A. and Canada, but as a result tend to be crowded.) | T2 | 169.505 |
| | T3 | 170.245 |
| | T8 | 171.905 |
| • For use only where there is no TV Channel 7: | 7I | 176.200 |
| • For use only where there is no TV Channel 8: | 8M | 183.200 |
| | 8S | 184.200 |
| • For use only where there is no TV Channel 9: | 9F | 187.600 |
| • For use only where there is no TV Channel 10: | 10C | 193.000 |
| • For use only where there is no TV Channel 11: | 11G | 199.800 |
| • For use only where there is no TV Channel 12: | 12L | 207.000 |

Specifications

Overall System

| | |
|-----------------------------|-----------------------------------|
| Operating Frequency | VHF high band, 169 MHz to 207 MHz |
| Frequency Stability | ± 0.005% |
| Modulation Mode | FM |
| Maximum Deviation | ±15 kHz |
| Operating Range | 200' minimum |
| Operating Temperature Range | 40° F (4° C) to 110° F (43° C) |
| Frequency Response | 100 Hz to 15 kHz |

Receiver

| | |
|---------------------------|---|
| Receiving System | Non-diversity single-channel dual antenna system |
| Image Rejection | 50 dB minimum |
| Signal-to-noise Ratio | 80 dB at 10 kHz deviation (IEC-weighted) |
| Total Harmonic Distortion | ≤1% (10 kHz deviation at 1 kHz) |
| Sensitivity | 10 µV for 60 dB S/N (IEC-weighted) |
| Audio Output | 350 mV (1 kHz modulation, 10 kHz deviation, 1M ohm load) |
| Power Supply | 12V DC, 300 mA, with provided AC adapter |
| Dimensions | 4.33" (110.0 mm) W x 1.38" (35.1 mm) H x 8.27" (210.1 mm) D |
| Net Weight | 10.2 oz (289 grams) |
| Accessory Included | AD1203A AC adapter |

UniPak™ Transmitter

| | |
|------------------------------|---|
| RF Power Output | 50 mW Max |
| Spurious Emissions | Under federal regulations |
| Dynamic Range | ≥90 dB |
| Input Connections | High impedance, low impedance, bias |
| Battery | 9V (NEDA type 1604) alkaline, not included |
| Current Consumption | 30 mA typical |
| Battery Life | Approximately 15 hours in High position Approximately 20 hours in Low position |
| Dimensions | 2.56" (65.0 mm) W x 4.33" (110.0 mm) H x 1.00" (25.4 mm) D |
| Net Weight (without battery) | 2.8 oz (78 grams) |

Handheld Transmitter

| | |
|------------------------------|---|
| RF Power Output | 50 mW Max |
| Spurious Emissions | Under federal regulations |
| Dynamic Range | ≥90 dB |
| Microphone Element | Dynamic unidirectional |
| Battery | 9V (NEDA type 1604) alkaline, not included |
| Current Consumption | 30 mA typical |
| Battery Life | Approximately 15 hours in High position Approximately 20 hours in Low position |
| Dimensions | 9.50" (241.3 mm) long, 2.10" (53.3 mm) diameter |
| Net Weight (without battery) | 12.7 oz (360 grams) |
| Accessory Included | AT8431 stand clamp |

Optional System Accessories

Wireless Essentials™ Microphones and Cables

All Wireless Essentials accessories are terminated for use with ATW-T27 and other UniPak™ transmitters.

| | |
|-------------------|--|
| AT829cW | Miniature cardioid condenser lavalier microphone. Includes clothing clip and windscreen. <i>Provided with PRO 127L system.</i> |
| MT830cW | Subminiature omnidirectional condenser lavalier microphone. Includes clothing clip and windscreen. |
| MT830cW-TH | "Theater" model, same as MT830cW except beige color mic and cable for concealment. |
| AT831cW | Miniature cardioid condenser lavalier microphone. Includes clothing clip and windscreen. |
| AT851cW | Surface-mount wide-range hemi-cardioid condenser microphone. |
| AT857AMLcW | 19" gooseneck cardioid microphone. Mounts to 5/8"-27 thread. Includes windscreen. |
| ATM35cW | Cardioid condenser instrument microphone. Includes AT8418 clip-on instrument mount. |
| ATM73cW | Headworn cardioid condenser microphone. Includes windscreen. |
| ATM75cW | Headworn cardioid condenser microphone. Includes windscreens and cable clip. |
| PRO 8HEcW | Headworn hypercardioid dynamic microphone. Includes windscreen and cable clip. <i>Provided with PRO 127H system.</i> |
| PRO 35xcW | Cardioid condenser instrument microphone. Includes AT8418 clip-on instrument mount. |
| AT-GCW | Hi-Z instrument/guitar cable with 1/4" phone plug. <i>Provided with PRO 127G system.</i> |
| XLRW | Connecting cable for UniPak transmitter with an XLR-type input connector, for Lo-Z microphones with XLRM-type output terminations. |

Other Accessories

| | |
|-----------------|---|
| AT8114 | Foam windscreen for handheld transmitter. |
| AT8141 | Water-resistant pouch for UniPak transmitter. |
| AT8390 | Shielded audio cable with 1/4" to 1/4" phone plugs. Available in a variety of lengths. (Also available with one straight and one 90° phone plug as the AT8316.) |
| AT8431 | Stand clamp for handheld transmitter, 5/8"-27 threads. |
| AT8633 | Rack-mount adapter kit allows mounting one or two PRO-R1 receivers in a single 19" rack space. |
| ATW-VP10 | Vinyl pouch with belt clip to hold UniPak transmitter. |

Notice to individuals *with implanted cardiac pacemakers or AICD devices:*

Any source of RF (radio frequency) energy *may* interfere with normal functioning of the implanted device. All wireless microphones have low-power transmitters (less than 0.05 watts output) which are unlikely to cause difficulty, especially if they are at least a few inches away. However, since a "body-pack" mic transmitter typically is placed against the body, we suggest attaching it at the belt, rather than in a shirt pocket where it may be immediately adjacent to the medical device. Note also that *any medical-device disruption will cease when the RF transmitting source is turned off.* Please contact your physician or medical-device provider if you have any questions, or experience any problems with the use of this or any other RF equipment.

One-Year Limited Warranty

Audio-Technica professional wireless systems purchased in the U.S.A. are warranted for one year from date of purchase by Audio-Technica U.S., Inc. (A.T.U.S.) to be free of defects in materials and workmanship. In event of such defect, product will be repaired promptly without charge or, at our option, replaced with a new product of equal or superior value if delivered to A.T.U.S. or an Authorized Service Center, prepaid, together with the sales slip or other proof of purchase date. ***Prior approval from A.T.U.S. is required for return.*** This warranty excludes defects due to normal wear, abuse, shipping damage, or failure to use product in accordance with the instructions. This warranty is void in the event of unauthorized repair or modification, or removal or defacing of the product labeling.

For return approval and shipping information, contact the Service Dept., Audio-Technica U.S., Inc., 1221 Commerce Drive, Stow, Ohio 44224.

Except to the extent precluded by applicable state law, ***A.T.U.S. will have no liability for any consequential, incidental, or special damages; any warranty of merchantability or fitness for particular purpose expires when this warranty expires.***

This warranty gives you specific legal rights, and you may have other rights which vary from state to state.

Outside the U.S.A., please contact your local dealer for warranty details.

